

# BH series

## Paddle joystick controllers

*Distinctive features and specifications*



- Hall effect joystick and switch function
- Sculpted ergonomic rubber grip
- 5V operation - standard dual redundant outputs
- Analog or PWM outputs
- Custom lever colors & designs available
- IP67 sealed
- EMC shielded
- 60mm above panel height

### ELECTRICAL SPECIFICATIONS

- Gain (Output Voltage Span):  $\pm 10\% \times V$  to  $\pm 50\% \times V$
- Output at Center:  $V/2 \pm (5\% \times \text{Gain})$
- Power Supply: 5V  $\pm 0.5V$  Transient free
- Switch Outputs: Open Drain, pulled high within paddle control via 1K5 to 5V, and smoothed to 0V with 100nF
- Sensor Type: Hall effect
- Current Consumption: <20mA
- Loads: Minimum 10K, preferred 100K+
- PWM frequency range: 100Hz to 1KHz

### MATERIALS

- Body: PA
- Actuator: PA & PC
- Rubber Grip: TPE

### GENERAL SPECIFICATIONS

- Operating Angle:  $\pm 30$  Degrees
- Life Cycles: 10 million cycles
- Soft touch lever with color options

### ENVIRONMENTAL SPECIFICATIONS

- Storage: -40°C to 85°C (-40°F to 185°F)
- Operating Temperature: -25°C to 70°C (-13°F to 158°F)
- Seal Above Panel: IP67 Dust & Water Ingress - to BS EN60529:1992+A2:2013
- Damp Heat – BS EN 60068-2-78:2002 Test Cab 21 days exposure @ +85°C 85%RH
- Salt Spray – BS EN 60068-2-11:1999 Test Ka 48 hours exposure @ +35°C with 5% NaCl
- Conducted Emissions: CISPR 25:2008 Ed. 3.0
- Radiated Emissions: CISPR 25:2008 Ed. 3.0, EN61000-6-4: 2011
- Radiated Immunity: ISO 11452-2: 2004 (150V/m), EN61000-6-2: 2005
- Conducted Immunity: ISO 11452-4: 2011
- Signal Cable Transients: EN 61000-6-2: 2005
- AC Magnetic Field Immunity: MIL-STD-461F
- Electrostatic Discharge: ISO 10605: 2008 inc A1: 2014 (8KV contact / 15KV air discharge) EN61000-4-2
- Random vibration according to ISO15003 level 1 in 3 axes 10...350Hz, Level 2, 8 hours/axis
- Bump - BS EN 60068-2-27:2009 40g 6ms half sine, 50 shock in each sense of each axis, total 300 shocks
- Freefall drop - BS EN 60068-2-31:2008 1000mm drop onto all faces and edges
- Shock - BS EN 60068-2-27:2009 50g 6ms half sine, 3 shocks in each sense of each axis, total 18 shocks



All parameters shown are based on a standard configuration and are provided for guidance only. Please contact APEM for assistance on how to achieve the best performance from your chosen configuration.

Note: The company reserves the right to change specifications without notice.

# BH series

## Paddle joystick controllers

### Overview

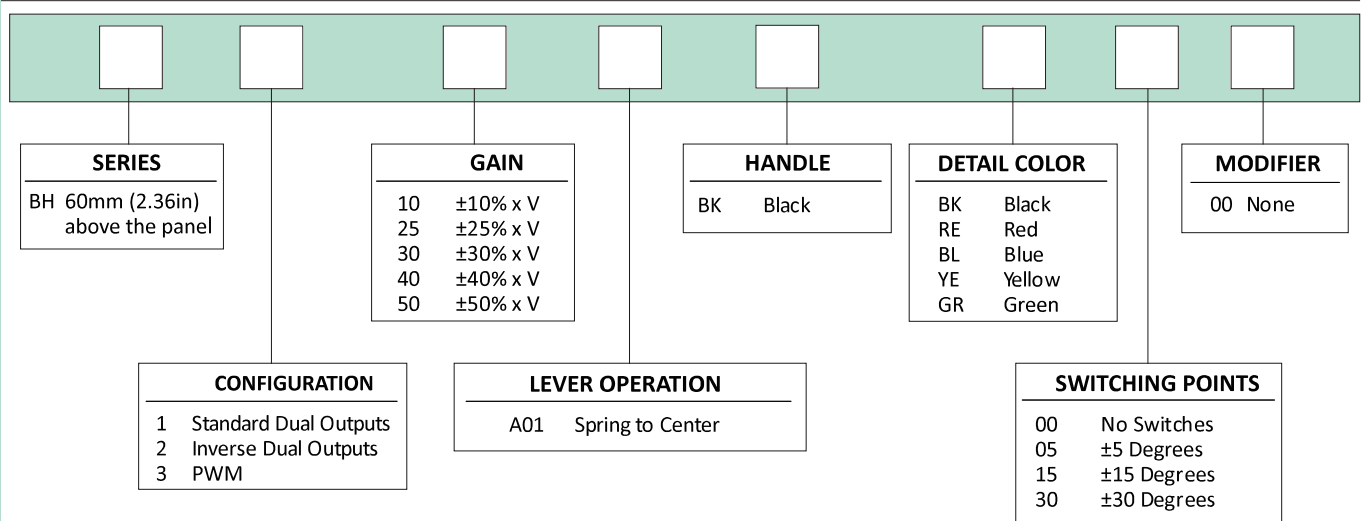

Intentionally  
left blank

# BH series

## Paddle joystick controllers

Overview

### GENERAL DIMENSIONS

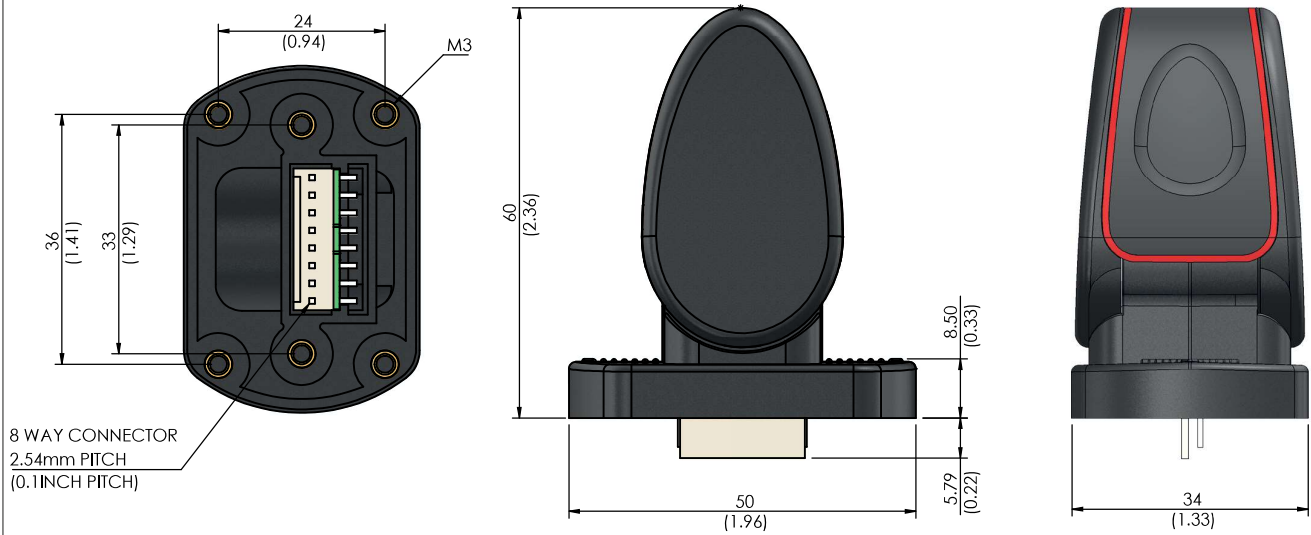

### DROP IN MOUNTING - PANEL CUT-OUT & MOUNTING INSTALLATION

The Paddle may be mounted with two different hole patterns:

- Two screws – in line on the Y axis (shown as yellow screws)
- Four screws – one in each corner (shown as silver screws)

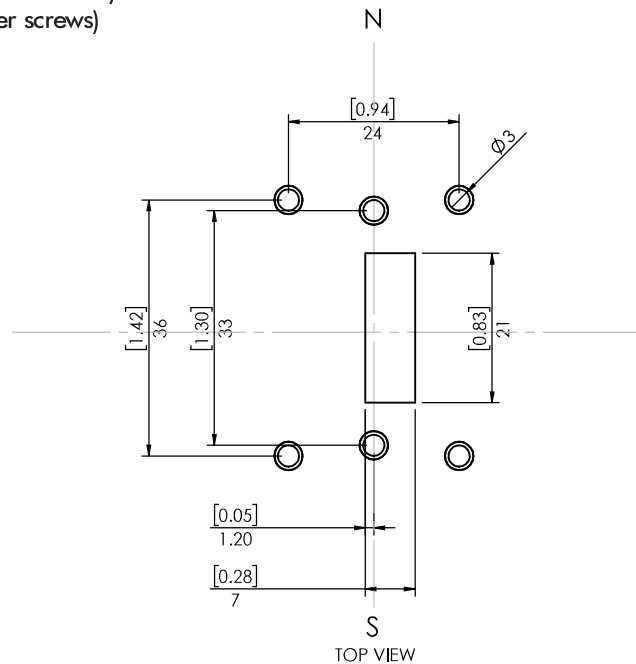
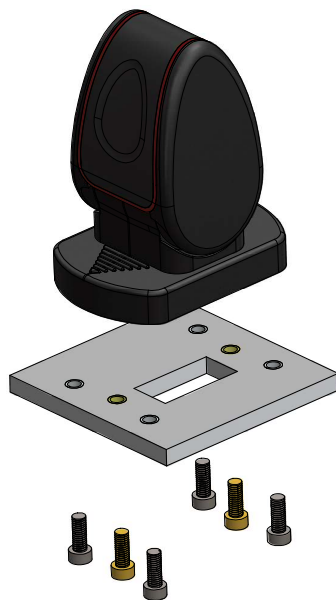

The Paddle is fitted with M3 bushes in all six positions, as standard.  
Fasteners are not supplied as standard. The appropriate length of fastener is dependent on panel thickness.

NOTE: All dimensions in mm/(inch).

# BH series

## Paddle joystick controllers

### Overview

#### MECHANISM

The brand new mechanism design has been developed for strength and long life while retaining a superb feel.

#### SPRING TO CENTER

The lever springs back to the center position when released.

#### CONNECTIONS

The paddle is fitted, as standard, with an industry standard 2.54mm pitch 8 way connector.

### CONNECTIONS

Paddles are supplied with an eight way connector as standard.

- PIN 1: 5V
- PIN 2: Switch 1(+)
- PIN 3: 0V
- PIN 4: Analog/PWM output 1
- PIN 5: Analog/PWM output 2
- PIN 6: 0V
- PIN 7: Switch 2 (-)
- PIN 8: 5V

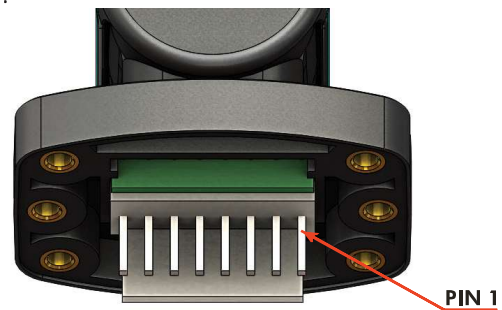

### BH SERIES DUAL OUTPUT CHARACTERISTICS

#### 40% GAIN INVERSE

Switches at 15 Degrees

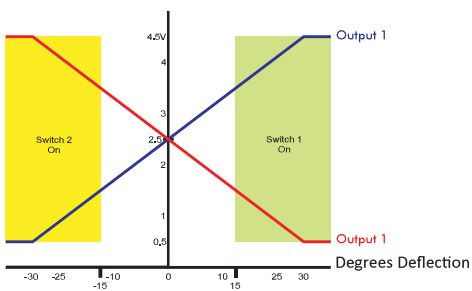

Switches at 30 Degrees

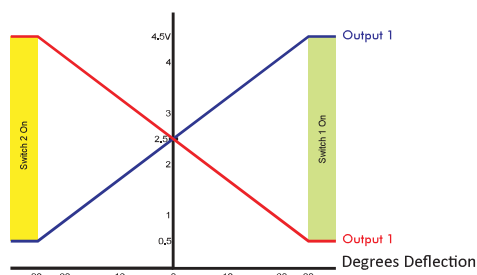

#### 40% GAIN

Switches at 15 Degrees

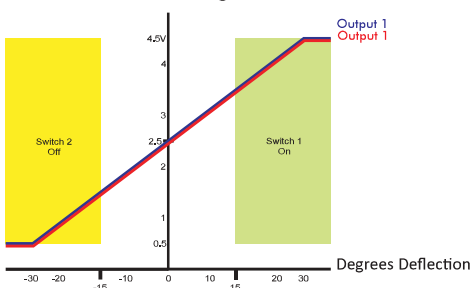

Switches at 30 Degrees

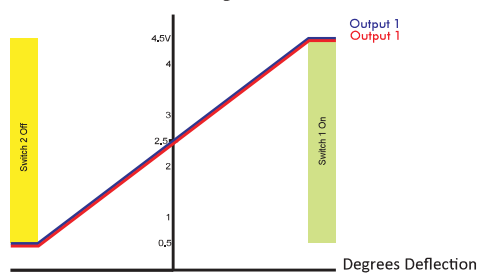

Equivalent circuit for the switch output

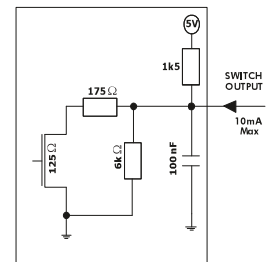

Note: When Dual Output (non-inverted) option is selected the polarity of Switch 2 is inverted

# BH series

## Paddle joystick controllers

Overview

### OUTPUT OPTIONS

The BH series paddle joystick is configured as two “electrical” controls in one mechanical package. The Paddle operates from 5V and provides two proportional outputs. The second output is accurate to the first within  $\pm 3\%$  of the power supply. The power supply for the secondary output is also completely independent. Customers may choose their preference of voltage outputs (gains).

The secondary output can be of the same or inverse polarity to the primary wiper. For example, with a secondary inverse output, the first and second outputs can be summed and compared to zero to verify that the joystick is operating correctly. Paddles having two identical outputs of the same polarity may be used to drive two identical dual redundant circuits.

There are also two Hall effect switches that trigger at pre-determined lever positions.

The BH series paddle joystick may be specified with a variety of PWM output options. For more details on available PWM options please refer to APEM.

### ADDITIONAL OUTPUT INFORMATION

#### SELECTABLE SWITCHING POINTS

The Paddle incorporates two Hall effect switches. The angle of the lever at the switch trigger point can be selected when ordering. If no switches are specified then the output on pins 2 and 7 will be unused. The outputs are configured as ‘open drain’ type with a 1K5 pull up resistor to 5V.

#### GAIN OPTIONS

The voltage output on the wiper, at full scale deflection is determined by the gain. The gain is expressed as a percentage of the voltage supplied. Therefore (assuming a 5V supply) a Paddle specified with  $\pm 25\%$  gain would yield 1.25V at South, 2.5V at center and 3.75V at North. A range of gain options are available as standard. All controls are supplied pre-set and no further calibration is needed throughout the lifetime of operation.

#### OUTPUT IMPEDANCE

The voltage outputs at center and at each end of travel are specified across an infinite load, with no current flowing. The output impedance specified in the electrical specification should be taken into account when designing a system. Load resistance of less than 10K Ohms is not recommended.

# BH series

## Paddle joystick controllers

### Overview

#### VOLTAGE OUTPUT OPTIONS

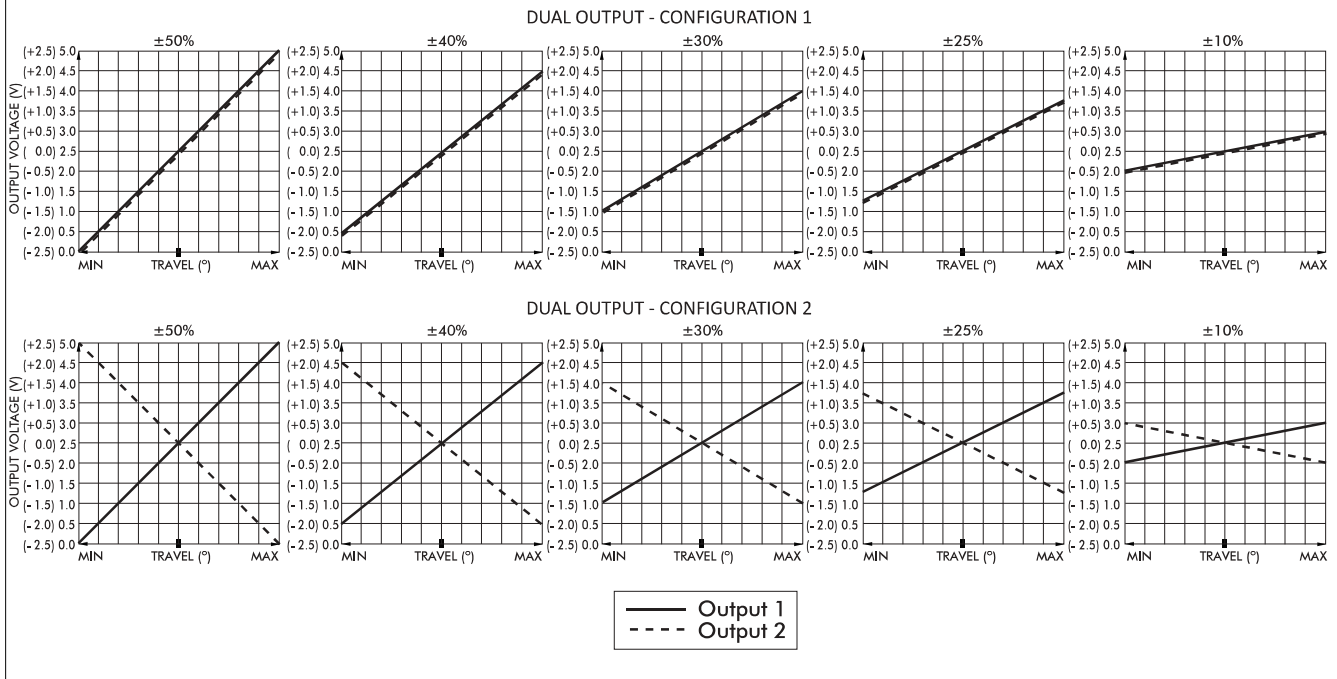

#### POWER SUPPLY

The BL is designed to be powered by a regulated  $5V \pm 0.5V$  power supply. The outputs are ratiometric, making a stable, noise free, power supply essential. The power supply to the joystick should be carefully regulated to be within tolerance. Should the power supply change outside of the specified tolerances, permanent damage may occur.

#### MAGNETIC IMMUNITY AND SYSTEM DESIGN

The BH Series incorporates internal magnetic screening to minimize the effect of external magnetic fields. Mounting or operating the Paddle close to strong magnetic fields is not recommended. System designers should follow best practice when incorporating the BH Series Paddle into their products. Care should be taken to decouple the power supply properly and to employ adequate EMC shielding.

#### MOUNTING

When mounting the Paddle, care should be taken to site it in a position that does not make vulnerable to damage when in use. If the Paddle is intended for use in a handheld enclosure then care must be taken to protect the Paddle from damage caused by dropping. For long term reliability, basic precautions should be implemented, such as mounting it at the lightest end of the enclosure or by protecting it with a guard. The body of the Paddle, on the underside of the panel, must not be subject to water spray, excessive humidity or dust.



Note: The company reserves the right to change specifications without notice.